

Heating with Gas



Modern Gas Heating

With fluctuating energy prices and a growing concern for the environment, it pays to modernize your outdated gas-fired boiler. You will save money, and the environment too.



At approximately 40%, domestic heating accounts for the greatest proportion of energy consumption and most CO₂ emissions. By replacing an outdated heating system with a modern solution, you can significantly improve energy utilization – reducing fuel consumption as well as harmful greenhouse gas emissions.

Reduce unnecessary waste

There are an estimated 20 million homes in the United States with heating systems 20 years of age or older[†]. For most of them, a significant share of energy and money go to waste unnecessarily every year due to outdated technology and an improperly sized system. Along with wasting energy, these boilers contribute to climate change by needlessly releasing harmful CO₂ emissions.

By replacing an outdated system with a gas-fired condensing boiler, a homeowner can expect to save as much as 30%* on their annual heating bills. This not only results in significant cost savings, but also environmental savings with reduced CO₂ emissions.

A modern solution

With the Vitodens 100-W, Vitodens 200-W and Vitodens 222-F Series, we offer a complete line of gas-fired condensing boilers.

Equipped with a corrosion-resistant stainless steel Inox-Radial heat exchanger, our Vitodens Series boilers can safely operate at extremely low boiler water temperatures. For you, this greater energy utilization translates into reduced heating costs as well as a smaller environmental footprint. Plus, our Vitodens Series gas-fired condensing boiler comes ready for the future by automatically adjusting to all gas types – including conditioned biogas.

It doesn't stop there

Our extensive product portfolio lets you take energy savings a step further. Reduce your energy costs by integrating domestic hot water production with your heating boiler, and manage the entire system with one of our control solutions. Or put the sun to work for you by adding a solar thermal package. With the entire system from one source, you don't have to compromise: total system performance and additional energy savings go hand-in-hand.

The Vitodens 200 gas-fired condensing boiler is prepared for the use of conditioned biogas.



[†]2005 Residential Energy Consumption survey by the Energy Information Administration.
* A condensing boiler and an outdoor reset control with a proper heat loss calculation.

Advanced Condensing Technology

A gas-fired condensing boiler is one of the most economical and clean ways to generate heat and can reduce your monthly heating bills, as well as your environmental footprint.

Condensing technology not only utilizes the heat from the combustion of gas, but also the unused heat that would escape up the chimney with a conventional heating system. Condensing boilers achieve excellent efficiency by extracting almost all of the heat contained in the flue gases and converting it into additional heating energy. To do this, Viessmann condensing boilers are equipped with a corrosion-resistant, stainless steel Inox-Radial heat exchanger, which cools the flue gases before they are routed into the chimney. By doing this, the water vapor contained within the gases is deliberately condensed, and the additional heat released is transferred into the heating system.

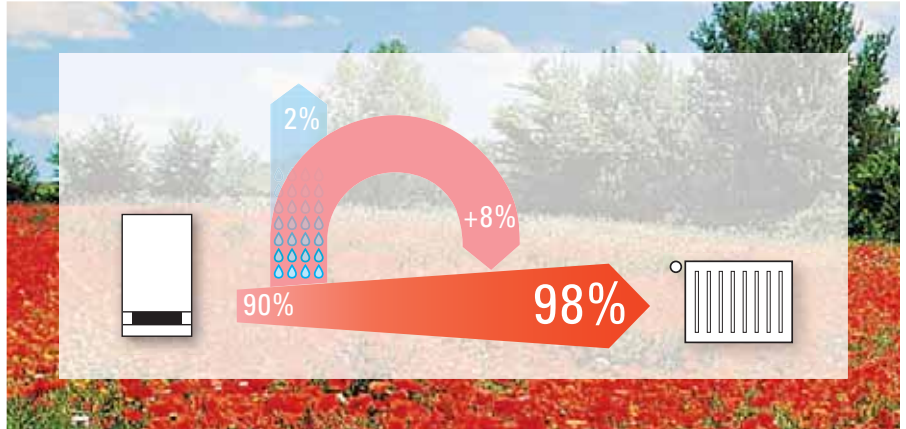

Through the condensation of the water vapor contained in the flue gas, additional heat is extracted from the flue gas and added back into the heating system. This increases efficiency and lowers your heating costs and environmental impact.

By choosing a condensing boiler, you will not only benefit from reduced monthly bills, but will also make an active contribution towards protecting the climate and the environment.

Save money with a modern, gas-fired condensing boiler



Energy savings

13% (\$154 p.a.)
of space heating gas

Cost savings (over 15 years)*

\$ 3,600

CO₂ savings (over 15 years)

11.5 t



Increase your savings with a solar domestic hot water system

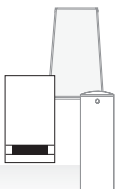

Additional energy savings

60% (\$136 p.a.)
of DHW gas

Additional cost savings (15 years)**

\$ 3,200

Additional CO₂ savings (over 15 years)

12 t



Savings shown in USD.

† 2005 Residential Energy Consumption Survey by the Energy Information Administration.

* Based on 83 MMBTU/p.a. (830 therms/2350m³) space heating load required (83% to 96% efficiency) at an average price of \$0.40/m³ (\$1.13/therm). Calculations include a 5% rise in energy prices per year.

** Based on 24 MMBTU/p.a. (240 therms/657m³) average annual household consumption for direct-fired hot water tank, 20 years of age at average gas price of \$0.40/m³ (\$1.13/therm).

Calculations include a 5% rise in energy prices per year.

VITODENS 100

The perfect mix of performance, quality and versatility.
Gas-fired wall-mounted condensing boiler, 37 - 118 MBH



The Vitodens 100 is ENERGY STAR® qualified and EcoLogo™ certified. By choosing the Vitodens 100, you are helping to promote cleaner air and a healthier environment.



Stainless steel Inox-Radial heat exchanger

Every home. Every budget.

With its outstanding design price/performance ratio, the Vitodens 100 is the perfect mix of performance and value. Its compact design, zero clearance to combustibles and extremely quiet operation make the Vitodens 100 an ideal choice even in the smallest spaces. Plus, with a residential lifetime warranty you can be sure your investment will deliver long-lasting performance year after year.

Reliable and consistent performance

Stainless steel is the best choice for long-term reliability. That's why the Vitodens 100 is equipped with a stainless steel Inox-Radial heat exchanger and Matrix cylinder burner. Developed and manufactured by Viessmann, these high-quality stainless steel components maximize performance and reliability. Plus, the "self-cleaning" heat exchanger contributes to the boiler's long service life and dependable performance.

Outstanding versatility

The Vitodens 100 offers the right solution for every demand – from multiple venting options to fuel flexibility (NG or LP) right out of the box. Plus, installation, service and maintenance are designed to be fast and easy with all pipe connections located at the bottom and serviceable components easily accessible from the front. You'll save time and money with fast service and maintenance calls.

Helps you save

Select an easy-to-use room thermostat, or, for greater control and additional energy savings, utilize the boiler's on-board control, which automatically adjusts the boiler water to outdoor temperatures. This not only boosts efficiency and fuel savings, but also keeps your home warm and comfortable at all times.

On-demand DHW with optional CombiPLUS Kit

With the new CombiPLUS Kit add on-demand domestic hot water (DHW) to your new Vitodens 100 space heating boiler and say goodbye to your DHW tank. Enjoy DHW at the snap of your fingers all day long with Low Lead Content Certification (NSF/ANSI 372), an outstanding flow rate of up to 3.6 GPM[†], plus added cost savings with the energy-efficient on-demand indirect-fired design.

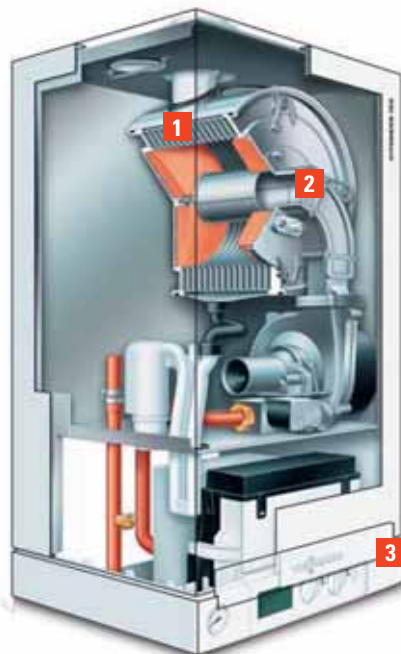

- 1 Inox-Radial heat exchanger
- 2 Modulating Matrix cylinder burner
- 3 On-board boiler control

[†]At a 63 °F maximum temperature rise with Vitodens 100, WB1B-35.
[‡]Certified to NSF/ANSI 372 for Low Lead Content.



Product not exactly as shown.

Optional CombiPLUS Kit

Slightly bigger than a large shoe box, the CombiPLUS Kit installs underneath or beside the boiler and requires only minimal piping and electrical connections. Featuring stainless steel heat exchanger, pressure bypass valve, DHW temperature and flow sensors, 3-speed pump, 3-way diverting valve, and Low Lead Content Certification[†], the CombiPLUS Kit provides reliable, high-quality DHW day after day.

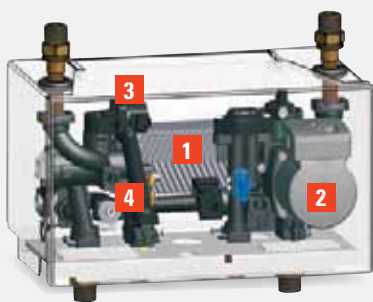

- 1 Stainless steel plate-type heat exchanger
- 2 3-speed DHW and space heating pump
- 3 3-way diverting valve
- 4 Water hammer arrestor

Specifications

- Viessmann made SA240 316 Ti stainless steel Inox-Radial heat exchanger constructed to CSA B51 and ASME Section IV
- Viessmann made stainless steel MatriX cylinder burner
- Two models from 37 to 118 MBH
- Ideal for any home and budget

Benefits at a glance

- Lasting performance with proven Viessmann made stainless steel Inox-Radial heat exchanger
- Low-emission combustion with Viessmann made stainless steel MatriX cylinder burner for natural gas or propane
- Certified to NSF/ANSI 372 for Low Lead Content
- Versatile on-board boiler control interfaces with most external controls – Integrated 0-10V and OpenTherm[®] communication ability
- Energy saving outdoor temperature sensor standard
- Greater venting flexibility with vent length up to 200 ft. and multiple venting options
- Easy installation and service with pipe connections located at the bottom and serviceable components accessible from the front
- Extremely quiet operation – quieter than most refrigerators
- Limited lifetime warranty in residential applications
- Expandable with CombiPLUS Kit for energy-efficient on-demand DHW

VITODENS 200

Industry-leading condensing technology for ultimate performance, reliability and comfort.
Gas-fired wall-mounted condensing boiler, 12 to 530 MBH



The Vitodens 200 is ENERGY STAR® qualified and EcoLogo™ certified. By choosing the Vitodens 200, you are helping to promote cleaner air and a healthier environment.



The intuitive Vitotronic 200 control with graphic user interface

Intelligent combustion control

The new Vitodens 200, B2HA is optimized for maximum performance with the intelligent Lambda Pro combustion management system, which adapts combustion to changing gas qualities and operating conditions automatically. This unique function becomes increasingly important as gas supplies vary in quality and heating value.

Efficient by design

At the core of the new Vitodens 200, B2HA are the Viessmann stainless steel Inox-Radial heat exchanger and MatriX cylinder burner. Together, they allow the greatest amount of heat extraction to be achieved with minimal loss (see diagram on opposite page).

Award winning control unit

The intuitive Viessmann-made Vitotronic 200, HO1B control manages the entire heating system and ensures economical

performance and maximum comfort at all times. The user-friendly, menu-driven control is capable of displaying multi-line text and graphics on a backlit display. The high-contrast, monochrome display offers excellent readability under poor lighting conditions.

The outdoor reset function automatically adapts the boiler operating temperature to the changing outdoor temperature. This reduces fuel consumption up to 15%, giving you excellent returns year after year on a modest initial investment. Plus, with system control for multiple zone space and DHW heating, the Vitotronic 200, HO1B offers even greater heating flexibility without additional external controls.

Your environmental choice

The Vitodens 200 is your efficient and environmentally-friendly choice for all applications. The low-emission MatriX cylinder burner guarantees clean, low-NOx combustion, while Lambda Pro ensures the highest efficiency at all times. With the Vitodens 200 you can actively contribute to protecting the environment – and your wallet – without compromising your warmth and comfort.

Strength in numbers

As many as eight Vitodens 200 gas-fired condensing boilers can be combined in a single prefabricated cascade system, with inputs up to 4240 MBH. As a cascade system fires boilers to meet fluctuating heating demands, it maintains maximum efficiency by precisely matching the load. A cascade system can also prevent interruption of heating plant operation, with multiple boilers available for back-up.



- 1 Inox-Radial heat exchanger
- 2 Modulating Matrix cylinder burner
- 3 Vitotronic 200 control



What is Lambda Pro?

By continuously monitoring the flame quality of the Matrix cylinder burner, the Lambda Pro combustion management system automatically adjusts the gas and combustion air ratio. Without any manual adjustments or conversions, the Vitodens 200 always maintains optimal performance.

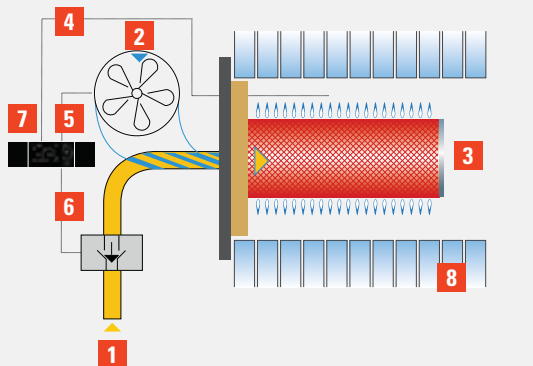

- | | |
|--------------------------|----------------------|
| 1 Gas supply | 5 Air signal |
| 2 Combustion air | 6 Gas signal |
| 3 Matrix cylinder burner | 7 Vitotronic control |
| 4 Flame signal | 8 Heat exchanger |

Specifications

- Viessmann-made SA240 316 Ti stainless steel Inox-Radial heat exchanger constructed to CSA B51 and ASME Section IV
- Viessmann-made stainless steel Matrix cylinder burner
- 9 models from 12 to 530 MBH (single-boiler installation)
- Exceeds Energy Star® Efficiency Requirements
- Suitable for altitude levels up to 10,000 ft. / 3,000 m

Benefits at a glance

- Best value in its class with new industry-leading technology and the most standard features
- Low-emission combustion for environmentally-friendly operation
- Intelligent Lambda Pro gas management system automatically adjusts to different gas qualities for optimum efficiency and performance
- New Vitotronic 200 control features large display with text and graphics for user-friendly operation
- Extended application range with increased capacity up to 530 MBH (single boiler) / 4240 MBH (cascade of 8 boilers)
- Modulation ratio up to 6.5:1 ensures extremely high efficiency
- Multiple venting options and greater venting flexibility with vent length up to 180 ft.
- Common venting up to four boilers[†]

[†] In accordance with local codes and regulations of authorities having jurisdiction.

VITODENS 222

Innovative, compact space heating and DHW.
Gas-fired floor standing condensing boiler, 12 to 125 MBH



The Vitodens 222-F is ENERGY STAR® qualified and EcoLogo™ certified.

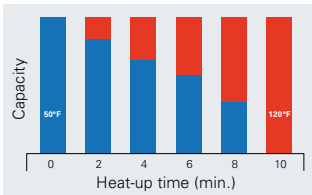

Advanced Storage Tank Loading System (STLS) ensures an extremely fast heat-up

Smart, compact space heating and DHW

The new Vitodens 222-F, B2TA gas-fired condensing boiler is an ideal space-saving option for new installations and a smart upgrade for outdated boiler and domestic hot water (DHW) storage systems. The floor standing Vitodens 222-F is available in two input sizes, offering compact, economical space heating and DHW solutions for homes with moderate heating loads.

Innovative Storage Tank Loading System (STLS)

Advanced Storage Tank Loading System technology in the Vitodens 222-F ensures a reliable and efficient DHW supply equivalent to that of a larger tank. The STLS utilizes an external plate heat exchanger and DHW loading pump for extremely fast heat-up capable of delivering a 10-minute peak flow of 60 gallons (model B2TA-35 only) or continuous DHW draw of 3.3 GPM*.

Award winning control unit

The intuitive Viessmann-made Vitotronic 200, HO1B control manages the entire heating system and maintains economical performance and maximum comfort at all times. The user-friendly, menu-driven control is capable of displaying multi-line text and graphics on a backlit display 70% larger than those of comparable units. The high-contrast, monochrome display offers excellent readability, even under poor lighting conditions.

An outdoor reset function automatically adapts the boiler operating temperature to the changing outdoor temperature. This reduces fuel consumption up to 15%, giving you excellent returns year after year on a modest initial investment. Plus, with system control for multiple zone space and DHW heating, the Vitotronic 200, HO1B offers even greater heating flexibility without additional external controls.

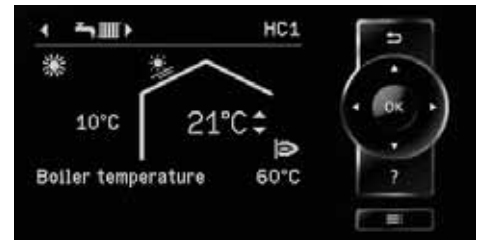

The intuitive Vitotronic 200 control with graphic user interface

- 1 Inox-Radial heat exchanger
- 2 Modulating Matrix cylinder burner
- 3 Vitotronic 200 control
- 4 Stainless steel storage tank
- 5 Heating expansion tank

* Based on a temperature rise of 70 °F (50 °F to 120 °F).



A heating surface made of stainless steel



At the heart of all Vitodens condensing boilers is a SA240 316Ti stainless steel, Viessmann-made Inox-Radial heat exchanger. A key component to outstanding efficiency, this high-performance heat exchanger delivers proven reliability and a long service life.

The MatriX burner is a milestone

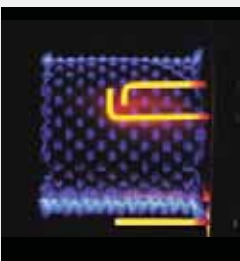

The MatriX cylinder burner, in combination with the Inox-Radial heat exchanger, ensures high energy efficiency. Plus, The MatriX burner's Lambda Pro combustion management system automatically adapts to changing gas type and quality for optimal efficiency.

Specifications

- Viessmann-made SA240 316Ti stainless steel Inox-Radial heat exchanger constructed to CSA B51 and ASME Section IV
- Viessmann-made stainless steel MatriX cylinder burner with Lambda Pro combustion management system for continuous efficiency and low emissions
- 2 models with input ranges from 12 to 125 MBH
- Viessmann-made SA240 316Ti stainless steel DHW storage tank (26 USG)
- Innovative DHW Storage Tank Loading System comprised of plate heat exchanger, DHW loading pump and storage tank
- Zero side clearance requirement
- Pre-installed pressure / temperature relief valves
- Fully enclosed heating expansion tank and circulation pump
- Exceeds Energy Star® Efficiency Requirements
- Built-in 3-speed DHW / space heating pump with diverter valve
- Suitable for altitude levels up to 10,000 ft. / 3,000 m
- Fast heat-up with Storage Tank Loading System
- 10-minute peak flow of 60 gallons (model B2TA-35 only)*
- Continuous DHW draw of 3.3 GPM*
- Wide modulation ratio up to 6.5:1
- Multiple venting options with vent length up to 180 ft.

Technical Specifications



Vitodens 100-W wall-mounted gas condensing boiler

Model	WB1B	26	35
Rated input	MBH	37 - 91	37 - 118
Altitude Levels	ft.	up to 10,000	up to 10,000
Dimensions			
Width x Height x Depth	in.	15.75 x 28.5 x 14.13	
Weight	lbs	78	78



Optional Combi**PLUS** Kit for on-demand DHW

Connected to Model	WB1B	26	35
DHW Supply Temperature	°F / °C	140 / 60	140 / 60
Continuous Draw Rate	USG/h	156 [†]	216 [†]
Dimensions			
Width x Height x Depth	in.	17 x 8.7 x 9.8	
Weight	lbs	25	25
Min./Max. distance between boiler and CombiPLUS	in.	11.5 / 36	11.5 / 36

[†] At a 63 °F maximum temperature rise.



Vitodens 200-W wall-mounted gas condensing boiler

Model	B2HA	19	28	35	45	60	80	100	112	150
Rated Input	MBH	12-67	19-100	19-125	60-160	60-212	104-285	104-352	113-399	113-530
Dimension										
Width	in.	17.75	17.75	17.75	19	19	19	19	23.63	23.63
Height	in.	41	41	41	40.63	40.63	43.5	43.5	44.5	44.5
Depth	in.	14	14	14	15	15	21	21	27.1	27.1
Weight	lbs	101	106	106	155	155	194	194	298	298



Vitodens 222-F gas condensing boiler and DHW heating

Model	B2TA	19	35
Rated input	MBH	12 - 67	19 - 125
Max. Allowable Working Pressure	psig	45	45
Dimensions			
Width x Height x Depth	in.	23.5 x 64 x 23.63	
Weight	lbs	282	282
DHW Storage Tank			
Capacity	USG	26.5	26.5
Max. Allowable Working Pressure	psig	150	150
Continuous Draw Rate*	gpm	1.8	3.3
Max. Draw Rate* (over 10 min. period)	USG	44	60

* Based on a temperature rise of 70 °F (50 °F to 120 °F).

Viessmann - The Company

Viessmann - climate of innovation

The Viessmann brand promise concisely expresses all that we hope to achieve. It is our key brand message and, together with our brand label, an identifying feature throughout the world. "Climate of innovation" is a promise on three levels: It is a commitment to a culture of innovation. It is a promise of high product utilization and, at the same time, an obligation to protect the environment.

Comprehensive range of products and services for all fuel types

Viessmann is one of the leading international manufacturers of heating systems and, with its comprehensive range of products and services, offers individual solutions of efficient systems for all applications and fuel types. As an environmental pioneer, the company has been supplying particularly efficient and clean heating systems for decades.

Acting in a sustainable manner

For Viessmann, to take responsibility, means a commitment to act in a sustainable way. This means bringing ecology, economy and social responsibility into harmony with each other, ensuring that current needs are satisfied without limiting the basis for life for the generations to come.

Efficiency program

With our efficiency program, Viessmann shows that the political goals set for 2020 with regard to climate and energy can already be achieved today with commercially available technology.

This project demonstrates:

- Environmental protection
- Efficiency with resources
- Securing manufacturing sites for the future

As a result, fossil fuels have been cut by 40 percent and CO₂ emissions reduced by a third.



Deutscher Nachhaltigkeitspreis

Deutschlands nachhaltigste Marke 2011

Viessmann won the German Sustainability Award 2011 for its commitment to climate protection and efficient use of resources.



For the particularly efficient utilization of energy through the innovative heat recovery center at the company's main site in Allendorf/Eder, Viessmann was rewarded with the Energy Efficiency Award 2010.

Viessmann Werke GmbH & Co. KG

Company details

- Established in: 1917
- Employees: 11,400
- Group turnover: \$2.8 billion USD
- Export share: 55 percent
- 16 factories in Germany, France, Canada, Poland, Hungary, Austria, Switzerland and China
- Operating in 74 countries
- 120 sales offices worldwide

Performance spectrum

- Condensing technology for oil and gas
- Solar thermal systems
- Heat pumps
- Wood combustion systems
- CHP modules
- Biogas plants
- Services

Viessmann Manufacturing Company Inc.

Waterloo, ON Canada
Tel. (519) 885-6300
Fax (519) 885-0887
www.viessmann.ca

Viessmann Manufacturing Company (U.S.) Inc.

Warwick, RI U.S.A.
Tel. (401) 732-0667
Fax (401) 732-0590
www.viessmann.us

Viessmann Manufacturing Company Inc.

Langley, BC Canada
Tel. (604) 533-9445
Fax (604) 533-9439
www.viessmann.ca

Other Viessmann Group facilities in North America

BIOFerm™ Energy Systems

Verona, WI U.S.A.
Tel. (608) 845-2193
www.bioferm-es.com



Viessmann Group

VIESSMANN

KW

KOB

MAWERA

ESS

BIOFERM

Schmack

Carbotech